

Bias Resistor Transistor

NPN Silicon Surface Mount Transistor with Monolithic Bias Resistor Network

This new series of digital transistors is designed to replace a single device and its external resistor bias network. The BRT (Bias Resistor Transistor) contains a single transistor with a monolithic bias network consisting of two resistors; a series base resistor and a base-emitter resistor. The BRT eliminates these individual components by integrating them into a single device. The use of a BRT can reduce both system cost and board space. The device is housed in the SC-59 package which is designed for low power surface mount applications.

- Simplifies Circuit Design
- Reduces Board Space
- Reduces Component Count
- The SC-59 package can be soldered using wave or reflow. The modified gull-winged leads absorb thermal stress during soldering eliminating the possibility of damage to the die.

- Available in 8 mm embossed tape and reel
- Use the Device Number to order the 7 inch/3000 unit reel.

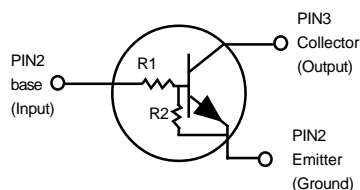

MUN2211RT1
MUN2212RT1
MUN2213RT1
MUN2214RT1
MUN2215RT1
MUN2216RT1
MUN2230RT1
MUN2231RT1
MUN2232RT1
MUN2233RT1
MUN2234RT1

NPN SILICON
BIAS RESISTOR
TRANSISTOR



CASE 318-03, STYLE 1
(SC - 59)

MAXIMUM RATINGS (T_A = 25°C unless otherwise noted)

Rating	Symbol	Value	Unit
Collector-Base Voltage	V _{CBO}	50	Vdc
Collector-Emitter Voltage	V _{CEO}	50	Vdc
Collector Current	I _C	100	mAdc
Total Power Dissipation @ T _A = 25°C ⁽¹⁾	P _D	200	mW
Derate above 25°C		1.6	mW/°C

THERMAL CHARACTERISTICS

Rating	Symbol	Value	Unit
Thermal Resistance — Junction-to-Ambient (surface mounted)	R _{θJA}	625	°C/W
Operating and Storage Temperature Range	T _J , T _{stg}	-65 to +150	°C
Maximum Temperature for Soldering Purposes	T _L	260	°C
Time in Solder Bath		10	Sec

DEVICE MARKING AND RESISTOR VALUES

Device	Marking	R1 (K)	R2 (K)
MUN2211RT1	8A	10	10
MUN2212RT1	8B	22	22
MUN2213RT1	8C	47	47
MUN2214RT1	8D	10	47
MUN2215RT1 ⁽²⁾	8E	10	∞
MUN2216RT1 ⁽²⁾	8F	4.7	∞
MUN2230RT1 ⁽²⁾	8G	1.0	1.0
MUN2231RT1 ⁽²⁾	8H	2.2	2.2
MUN2232RT1 ⁽²⁾	8J	4.7	4.7
MUN2233RT1 ⁽²⁾	8K	4.7	47
MUN2234RT1 ⁽²⁾	8L	22	47

1. Device mounted on a FR-4 glass epoxy printed circuit board using the minimum recommended footprint.
2. New devices. Updated curves to follow in subsequent data sheets.

MUN2211RT1 SERIES

ELECTRICAL CHARACTERISTICS (T_A = 25°C unless otherwise noted)

Characteristic	Symbol	Min	Typ	Max	Unit	
OFF CHARACTERISTICS						
Collector-Base Cutoff Current (V _{CB} =50V, I _E = 0)	I _{CBO}	-	-	100	nAdc	
Collector-Emitter Cutoff Current (V _{CE} = 50 V, I _B = 0)	I _{CEO}	-	-	500	nAdc	
Emitter-Base Cutoff Current (V _{EB} = 6.0 V, I _C = 0)	MUN2211RT1	I _{EBO}	-	-	0.5	mAdc
	MUN2212RT1		-	-	0.2	
	MUN2213RT1		-	-	0.1	
	MUN2214RT1		-	-	0.2	
	MUN2215RT1		-	-	0.9	
	MUN2216RT1		-	-	1.9	
	MUN2230RT1		-	-	4.3	
	MUN2231RT1		-	-	2.3	
	MUN2232RT1		-	-	1.5	
	MUN2233RT1		-	-	0.18	
MUN2234RT1		-	-	0.13		
Collector-Base Breakdown Voltage (I _C = 10 μA, I _E = 0)	V _{(BR)CBO}	50	-	-	Vdc	
Collector-Emitter Breakdown Voltage ⁽³⁾ (I _C =2.0mA, I _B =0)	V _{(BR)CEO}	50	-	-	Vdc	
ON CHARACTERISTICS ⁽³⁾						
DC Current Gain (V _{CE} = 10 V, I _C = 5.0 mA)	MUN2211RT1	h _{FE}	35	60	-	
	MUN2212RT1		60	100	-	
	MUN2213RT1		80	140	-	
	MUN2214RT1		80	140	-	
	MUN2215RT1		160	350	-	
	MUN2216RT1		160	350	-	
	MUN2230RT1		3.0	5.0	-	
	MUN2231RT1		8.0	15	-	
	MUN2232RT1		15	30	-	
	MUN2233RT1		80	200	-	
MUN2234RT1		80	150	-		
Collector-Emitter Saturation Voltage (I _C =10mA, I _E =0.3mA)	V _{CE(sat)}	-	-	0.25	Vdc	
(I _C = 10 mA, I _B = 5 mA) MUN2230RT1 MUN2231RT1						
(I _C = 10 mA, I _B = 1 mA) MUN2215RT1 MUN2216RT1 MUN2232RT1 MUN2233RT1 MUN2234RT1						
Output Voltage (on)	V _{OL}				Vdc	
(V _{CC} =5.0V, V _B =2.5V, R _L =1.0kΩ)	MUN2211RT1					
MUN2212RT1 MUN2214RT1 MUN2215RT1 MUN2216RT1		-	-	0.2		
MUN2230RT1 MUN2231RT1 MUN2232RT1 MUN2233RT1						
MUN2234RT1						
(V _{CC} =5.0V, V _B =3.5V, R _L = 1.0kΩ)	MUN2213RT1			0.2		

3. Pulse Test: Pulse Width < 300 ms, Duty Cycle < 2.0%

MUN2211RT1 SERIES

ELECTRICAL CHARACTERISTICS ($T_A = 25^\circ\text{C}$ unless otherwise noted) (Continued)

Characteristic	Symbol	Min	Typ	Max	Unit
Output Voltage (off) ($V_{CC} = 5.0\text{V}$, $V_B = 0.5\text{V}$, $R_L = 1.0\text{k}\Omega$) ($V_{CC} = 5.0\text{V}$, $V_B = 0.050\text{V}$, $R_L = 1.0\text{k}\Omega$) ($V_{CC} = 5.0\text{V}$, $V_B = 0.25\text{V}$, $R_L = 1.0\text{k}\Omega$)	V_{OH}	4.9	—	—	Vdc
MUN2230RT1					
MUN2215RT1					
MUN2216RT1					
MUN2233RT1					
Input Resistor	R_1	7.0	10	13	$\text{k}\Omega$
MUN2211RT1					
MUN2212RT1		15.4	22	28.6	
MUN2213RT1		32.9	47	61.1	
MUN2214RT1		7.0	10	13	
MUN2215RT1		7.0	10	13	
MUN2216RT1		3.3	4.7	6.1	
MUN2230RT1		0.7	1.0	1.3	
MUN2231RT1		1.5	2.2	2.9	
MUN2232RT1		3.3	4.7	6.1	
MUN2233RT1		3.3	4.7	6.1	
MUN2234RT1		15.4	22	28.6	
Resistor Ratio	R_1/R_2	0.8	1.0	1.2	
MUN2211RT1 MUN2212RT1 MUN2213RT1					
MUN2214RT1		0.17	0.21	0.25	
MUN2215RT1 MUN2216RT1		—	—	—	
MUN2230RT1 MUN2231RT1 MUN2232RT1		0.8	1.0	1.2	
MUN2233RT1		0.055	0.1	0.185	
MUN2234RT1		0.38	0.47	0.56	

MUN2211RT1 SERIES

TYPICAL ELECTRICAL CHARACTERISTICS
MUN2211RT1

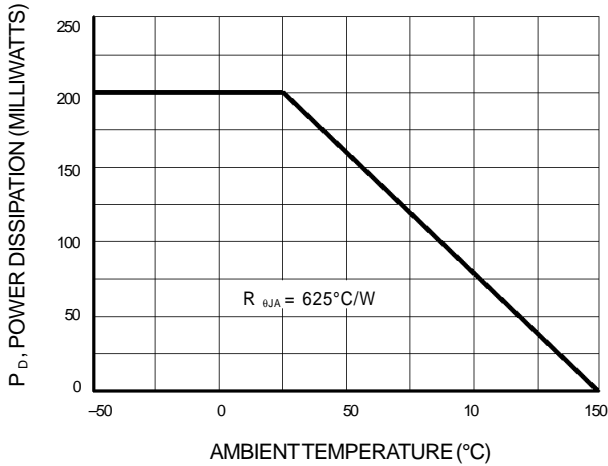

Figure 1. Derating Curve

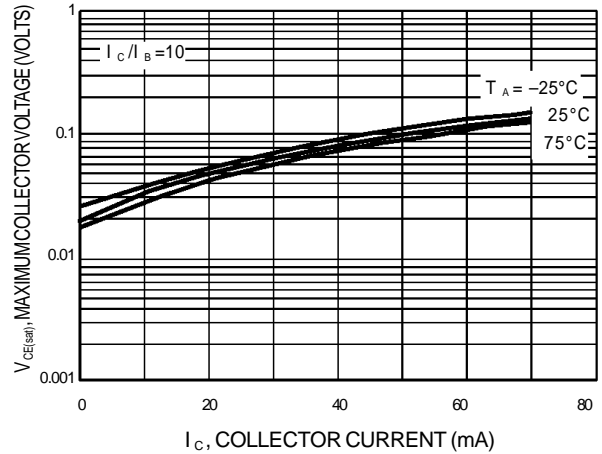

Figure 2. $V_{CE(sat)}$ versus I_C

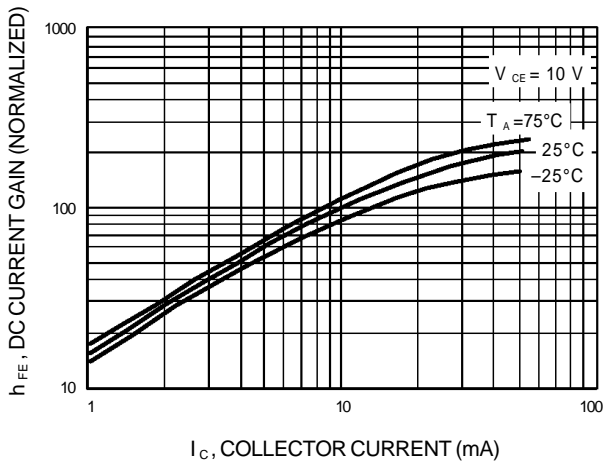

Figure 3. DC Current Gain

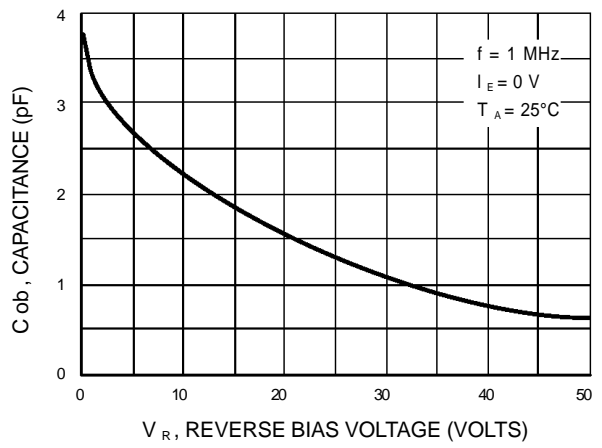

Figure 4. Output Capacitance

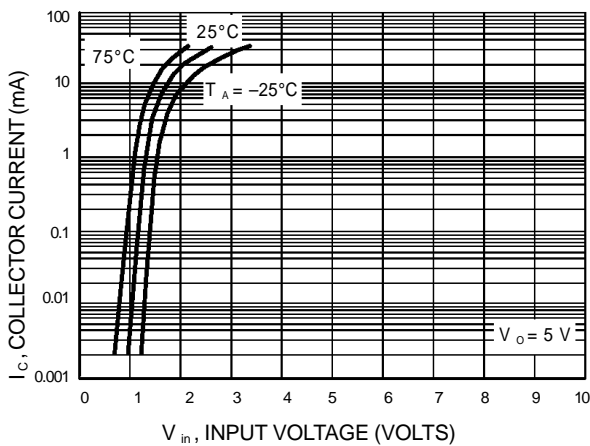

Figure 5. Output Current versus Input Voltage

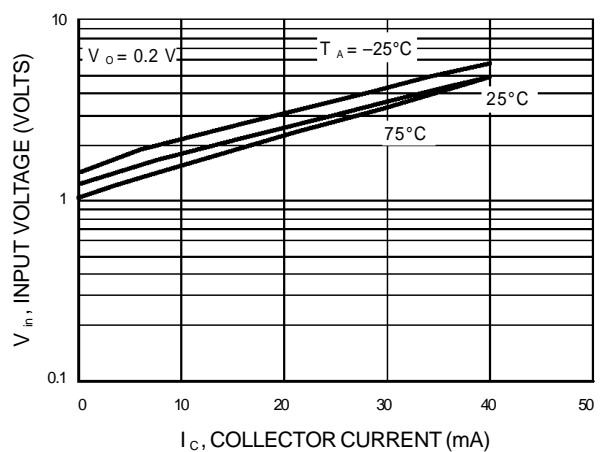

Figure 6. Input Voltage versus Output Current

MUN2211RT1 SERIES

TYPICAL ELECTRICAL CHARACTERISTICS

MUN2212RT1

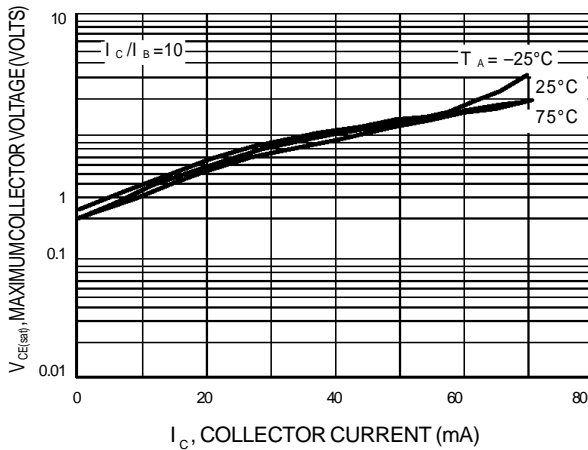

Figure 7. $V_{CE(sat)}$ versus I_C

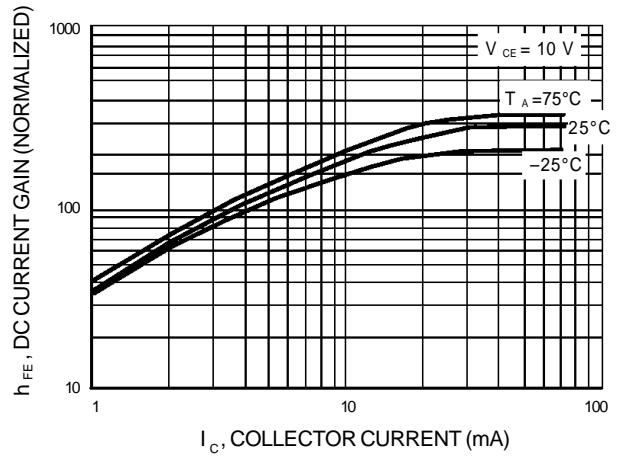

Figure 8. DC Current Gain

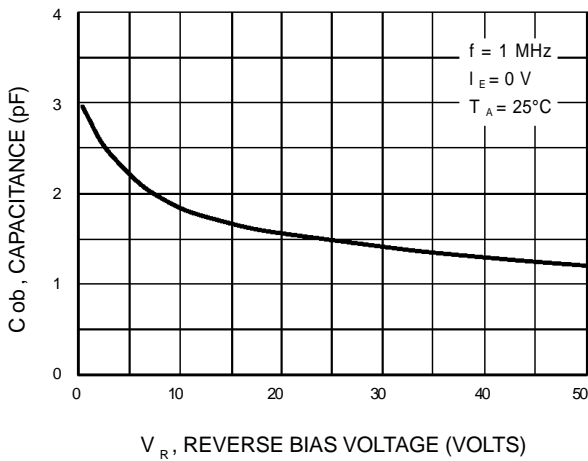

Figure 9. Output Capacitance

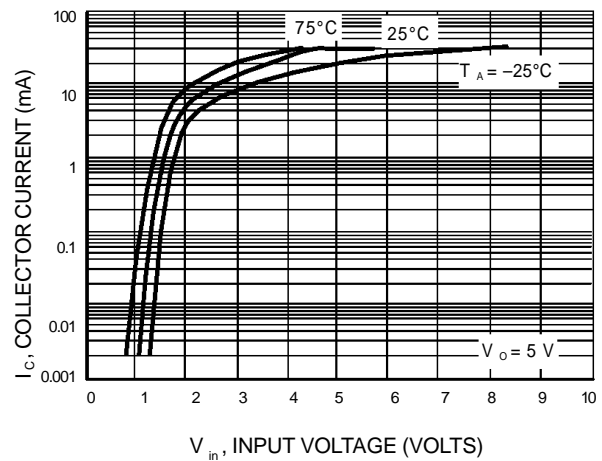

Figure 10. Output Current versus Input Voltage

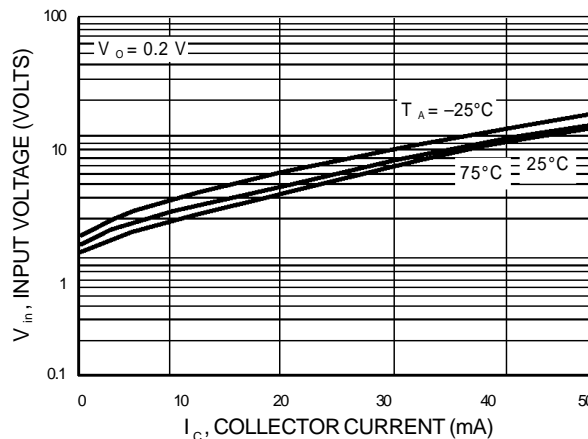

Figure 11. Input Voltage versus Output Current

MUN2211RT1 SERIES

TYPICAL ELECTRICAL CHARACTERISTICS
MUN2213RT1

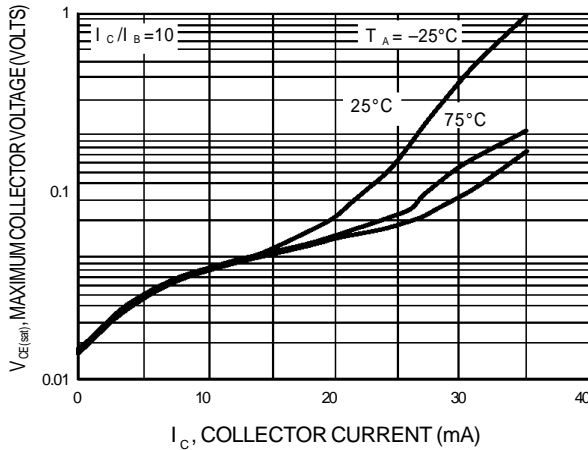

Figure 12. $V_{CE(sat)}$ versus I_C

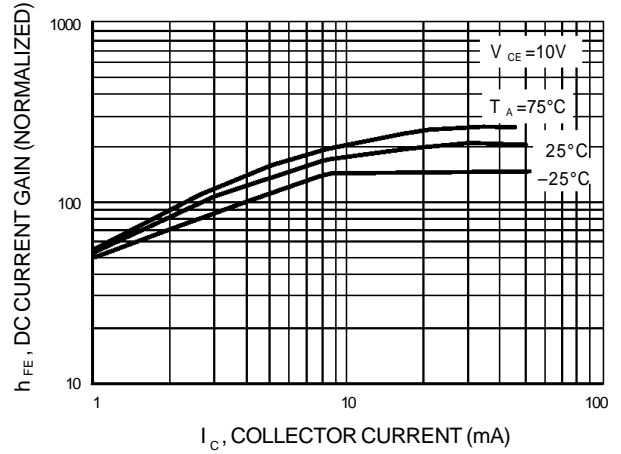

Figure 13. DC Current Gain

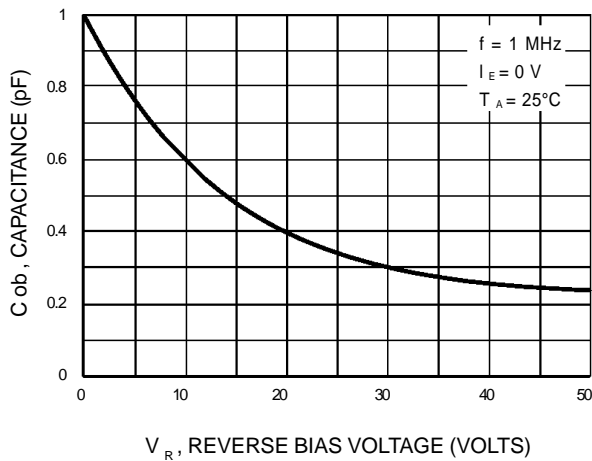

Figure 14. Output Capacitance

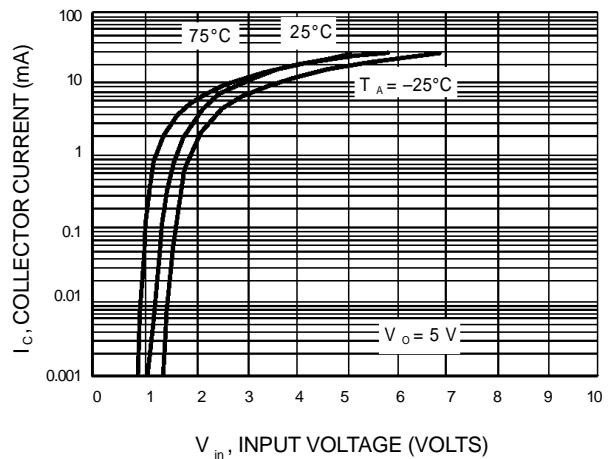

Figure 15. Output Current versus Input Voltage

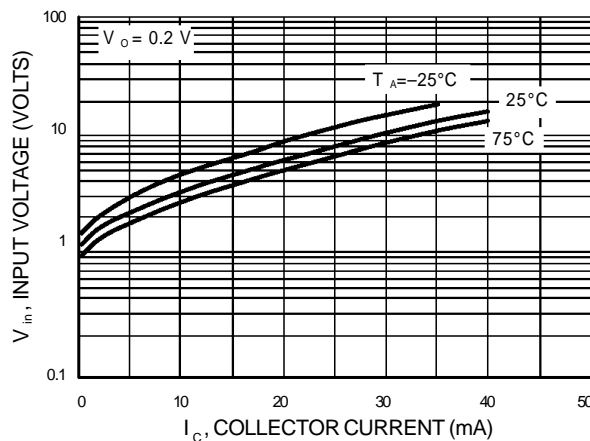

Figure 16. Input Voltage versus Output Current

MUN2211RT1 SERIES

TYPICAL ELECTRICAL CHARACTERISTICS
MUN2214RT1

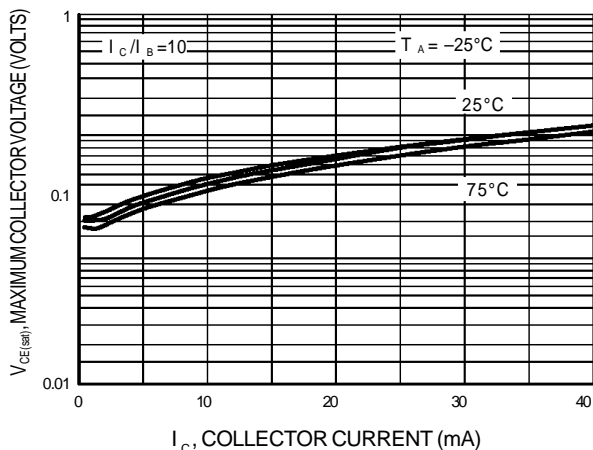

Figure 17. $V_{CE(sat)}$ versus I_C

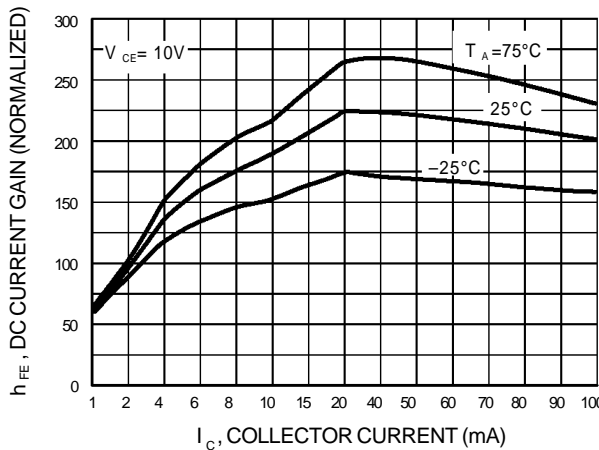

Figure 18. DC Current Gain

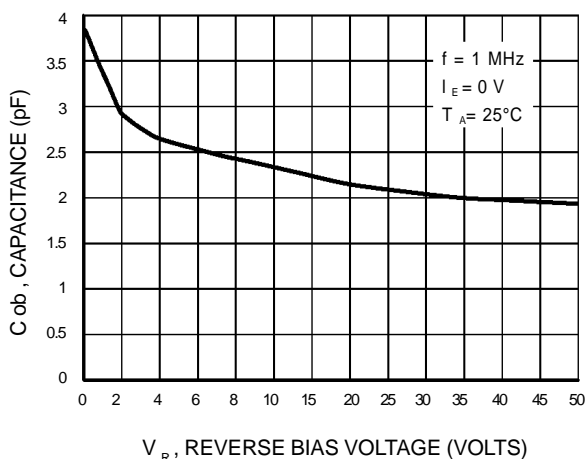

Figure 19. Output Capacitance

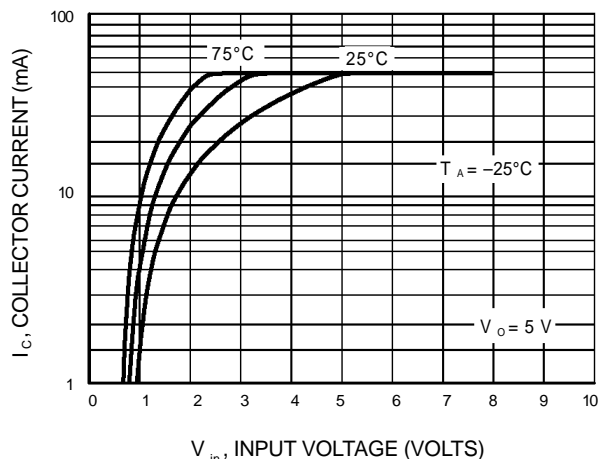

Figure 20. Output Current versus Input Voltage

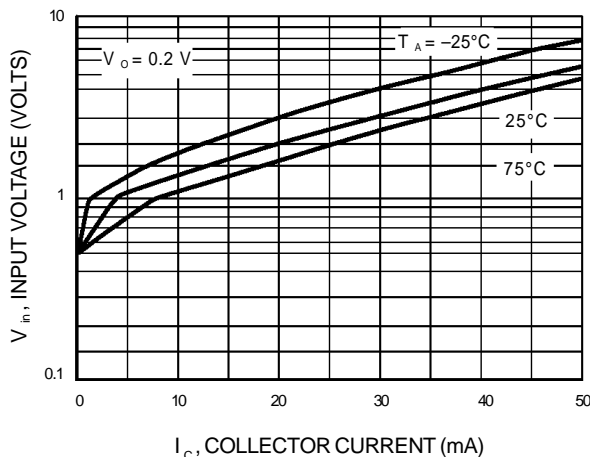

Figure 21. Input Voltage versus Output Current

MUN2211RT1 SERIES

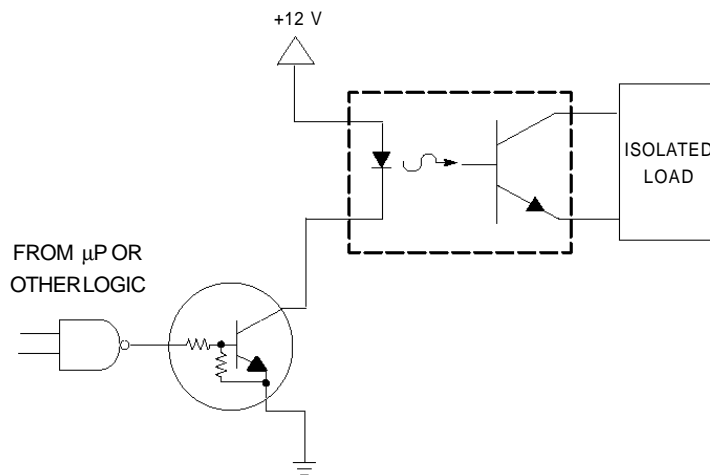

Figure 22. Level Shifter:
Connects 12 or 24 Volt Circuits to Logic

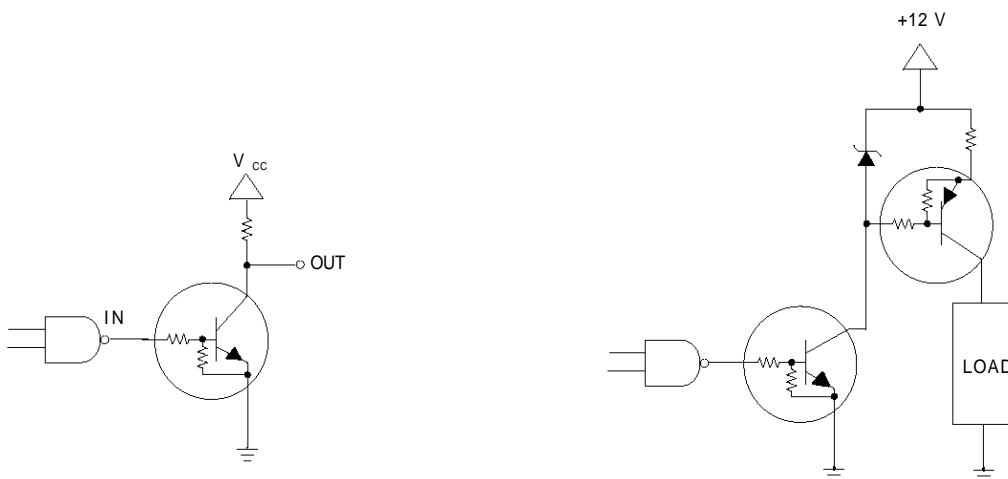

Figure 23. Open Collector Inverter:
Inverts the Input Signal

**Figure 24. Inexpensive, Unregulated
Current Source**